

PLEATED BLIND FACE FIXING FITTING INSTRUCTIONS

FITTING COMPONENTS

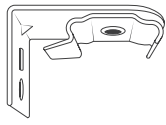

Face fix brackets:
quantity to suit
length of blind



Wood screws:
4+

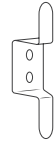

Accumulation
device

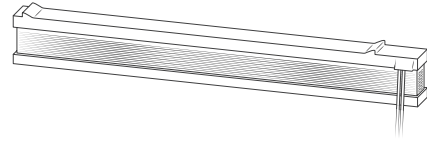

Blind

FITTING HARDWARE



Metal tape
measure



Drill



Philips head
screwdriver



Stepladder



Drill bit



Pencil

1 BRACKET POSITION

Place blind in fitting position, space the brackets evenly.

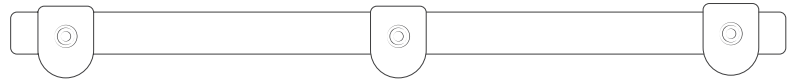

2 INSTALLING BRACKETS

Face Fixing

Position bracket against the surface and mark out the holes in the top of the bracket. Use rawl plugs if fitting to the wall.

The headrail shall not be installed at less than 1.5 m from the floor.

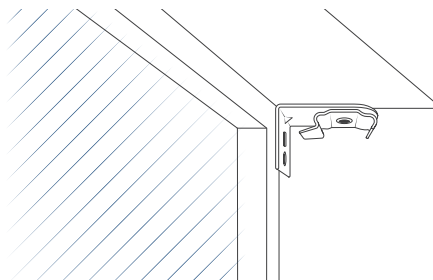

3 FITTING THE HEADRAIL

Clip the headrail onto the bracket by resting the rail onto position A and press back.

To remove the rail, depress the rail back into the bracket and pull out at a forward tilt.

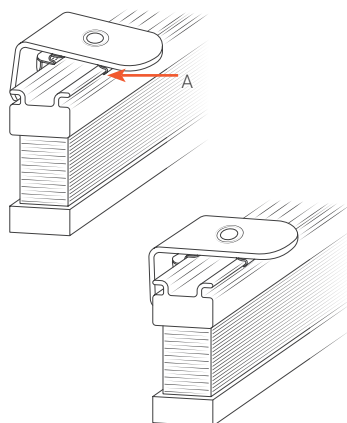

4 OPERATING THE BLIND

- To lower the blind, release the cord by moving it to the left until the cord lock releases and gently let the cord slide through your fingers.
- To raise the blind, pull the cord down until the blind is at the height you want. Move the cord to the right and the cord lock will lock automatically.

Accumulation Device (Safety Cleat)

The accumulation device shall be installed as close to the headrail as possible, and no less than 1.5m from the floor.

1. Use double sided tape, or similar, to stick the tensioning device to the wall temporarily while preparing to drill and screw permanently into place.
2. Always wrap all loose cords around the cleat in a figure of 8 pattern.



Young children can be strangled by loops in pull cords, chains, tapes, and inner cords that operate the product. To avoid strangulation and entanglement, keep cords out of the reach of young children. Cords may become wrapped around a child's neck. Move beds, cots, and furniture away from window covering cords. Do not tie cords together. Make sure cords do not twist and create a loop.

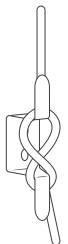

Assembly and installation of this product can be completed by non-professionals, in accordance with current trade and safety standards. Please consult a professional if any doubt exists.