

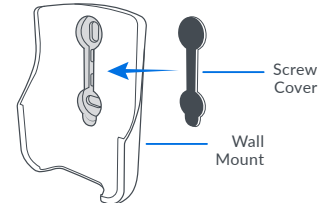

GET TO KNOW YOUR REMOTE

Your ComfyShade remote control operates your blinds using the ▲, ■, and ▼ buttons.

Each remote features five **channels**. Up to ten blinds can be added per channel, and you can select which channel you'd like to control using the ◀ and ▶ buttons. Your chosen channel will be displayed at the top of the remote control.

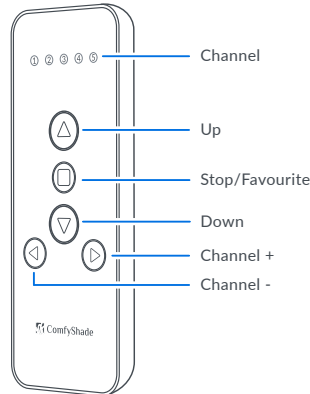

Powering Your Remote

Before setting up your blind, you need to first insert the battery provided into the remote control. To do so, use the screwdriver provided to loosen the screw on the back of the remote control until the panel becomes loose. Please note, for safety, the screw does not fully detach from the panel. Once the back panel is removed, simply clip the battery in place as indicated.

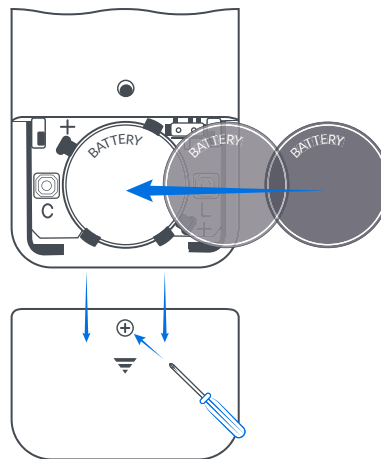

What is a channel? Your remote has five channels, and each channel can have up to ten blinds paired to it. When you issue an up or down command, it will be issued to all blinds on that channel. For example, you might have three blinds side by side in your bay window and you want them to always move in unison - it makes sense to put them all on the same channel as then you only need to click down once. However, if you want to control them individually, you'll need to put each on its own channel. When you cycle through the channels on the remote, you have the opportunity to control each channel independently. After channel 5, all channels will be highlighted, allowing you to control all 5 channels at once. In our bay window example, this would allow you to have one blind set per channel, but still have a way to move them all at once. There's no right or wrong way - just what works best for you and your home!



BEFORE PAIRING YOUR REMOTE CONTROLLER TO YOUR BLIND

1 Charging The Motor

Once your blind is fitted to your window, use a USB-C charger to charge the motor on your blind. A red LED will indicate the motor is charging. Leave the blind for 3-4 hours, or until the LED turns green which indicates the battery is fully charged.

2 Waking Up The Motor

To activate the motor, use a pin or paperclip to press the **Setting** button for one second. The blind will jog twice, beep four times and flash the green LED to indicate it is awake.

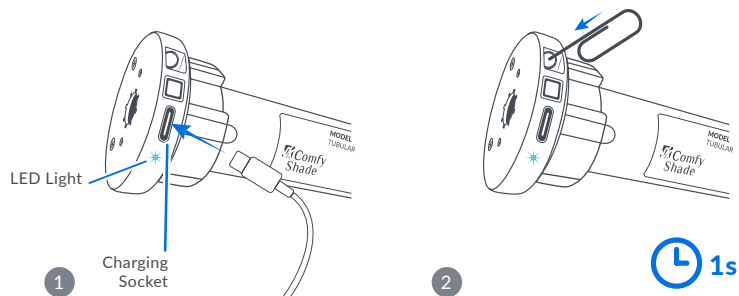

1

Pairing A Blind To A Remote

- 1 Press the **Manual** button for three seconds. Release the button when the red LED flashes and the motor jogs twice. The motor will beep for ten seconds waiting for the remote to be paired.
- 2 Press **■** on your remote control within ten seconds. The motor will jog twice, beep, and the green LED will flash. Your blind is now paired to your remote.

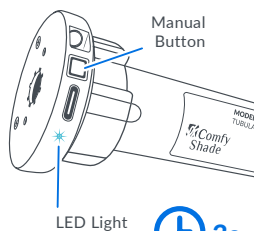

1

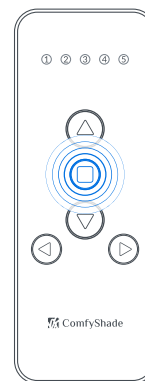

2

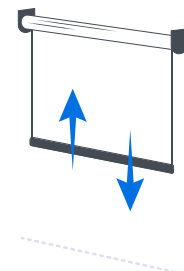

2

Checking The Direction Of Travel

- 1 Check the direction of travel by tapping **▼** on your remote until the blind moves. Press **■** to stop the blind moving if necessary. If the blind moves downwards, it is correctly set up and you can progress to the next section.

Note: if the blind does not move, restart step one of Pairing A Blind To A Remote.

- 2 However, if the blind moves up while tapping **▼** simply press and hold both **▲** and **▼** simultaneously until the motor jogs and beeps. Press **▼** to lower your blind and verify the direction is now correct.

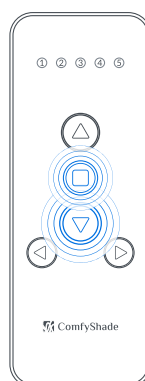

1

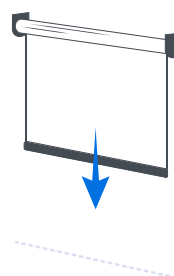

2

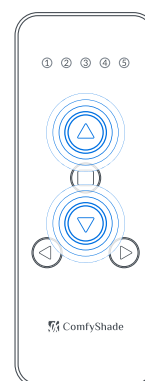

3

Setting Your Blind's Closed Positions

- 1 To set the closed position for your blind, press and hold **▼** to move your blind.
- 2 Once at the desired position press **■** to stop the blind.
- 3 You can fine tune this by tapping **▲** and **▼** as required.
- 4 Once the blind is in your preferred closed position, press **▼** and **■** simultaneously. The motor will jog twice, beep and the green LED will flash to confirm your closed position.

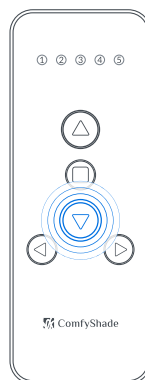

1

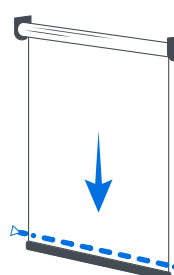

2

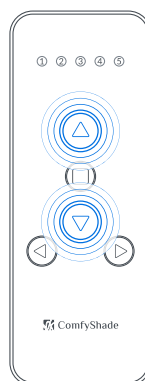
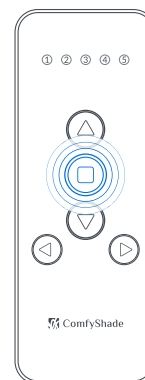

3

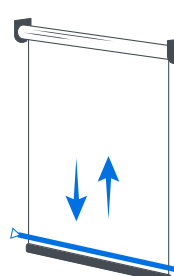

4

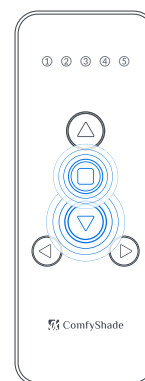

Setting Your Blind's Open Positions

- 1 To set the open position, press and hold ▲ to move your blind.
- 2 Once at the desired position press ■ to stop the blind.
- 3 You can fine tune this by tapping ▲ and ▼ as required.
- 4 Once the blind is in your preferred open position, press ▲ and ■ simultaneously. The motor will jog twice, beep and the green LED will flash to confirm your closed position.

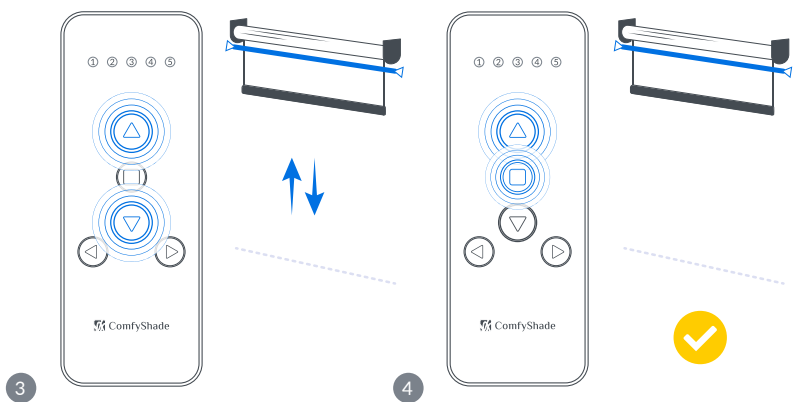
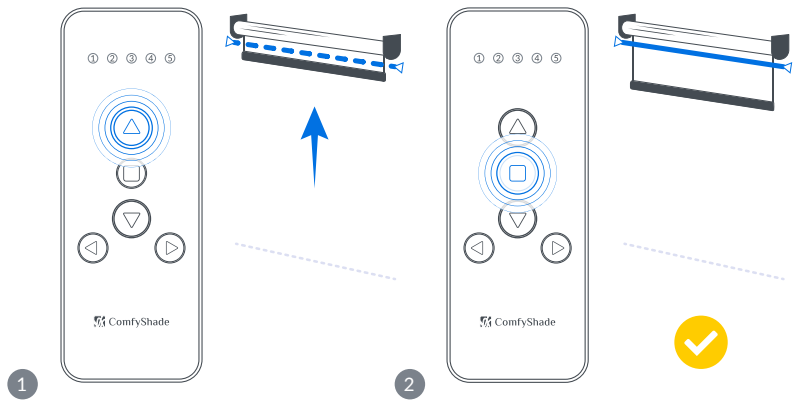

Recharging The Battery

Depending on the size of your blinds, the motor will need recharging typically every 3-6 months. Your motor contains a built-in rechargeable battery, and will beep when it needs recharging.

To charge the battery, simply plug in the power adapter for 3-4 hours or until the LED turns green.

Note: If the red light does not come on when charging, ensure the charger is fully inserted and that the plug is turned on at the socket. If the light still doesn't come on, try an alternative USB-C charger.

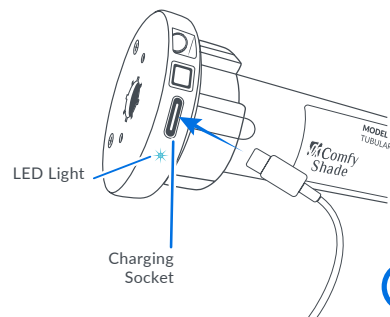

⌚ 3-4h



Changing Motor Speed

To change the speed of your motor:

Remove the panel from the back of the remote.
Press the L button to change the motor speed to:

Low speed (20rpm/25rpm):

The motor will beep once and jog once.

Middle speed (25rpm/25rpm):

The motor will beep twice and jog twice.

High speed (25rpm/30rpm):

The motor will beep three times and jog three times.

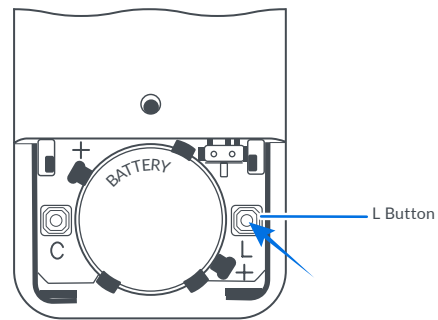

Pairing A Second Remote To Your Blind

- 1 Remove the panel from the back of the remote used to set up the blind (remote A) and press the L button for three seconds. The motor will jog twice and beep.
- 2 Press **■** on your second remote (remote B). The motor will jog twice, beep and the green LED will flash. You can now operate your blind with either remote.

Note: To delete other remote controls, remove the panel from remote A then press and hold the C button. The motor will jog twice and beep. You have now deleted all other remote controls from the blind.

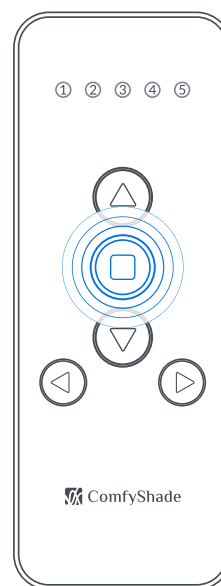
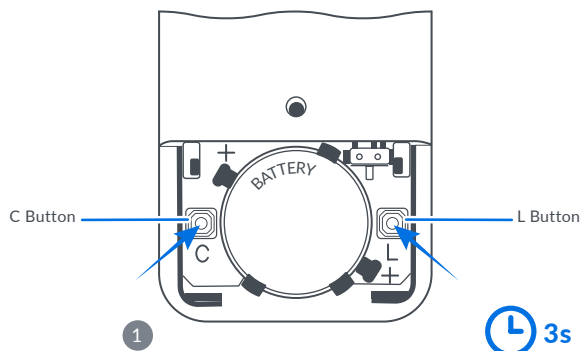



ADVANCED SETTINGS

Setting A Favourite Position

A **favourite** position is a third setting you can set between the open and closed limits. This might be half way open to specifically block out the low mid-afternoon sun that gets in your eyes when relaxing on the sofa, or three quarters up to stop the morning sun glaring onto your computer when working. This flexibility allows you to click a button and the blind will move to that exact position, instead of having to wait and press stop.

Using ▲ and ▼ as required, find a position that you'd like to favourite. Once you've found your favourite position, press ■ for three seconds. The motor will jog twice, beep, and the green LED will flash to confirm your new favourite position.

To move the blind to your favourite position, simply press ■.

To adjust your favourite position move your blind using ▲ and ▼ to a replacement position and repeat the process.

Adjusting Open & Closed Positions

To modify the open position:

Press and hold ■ and ▲. When the motor jogs and beeps, release the buttons.

Press and hold ▲ or ▼ as required until the blind is in your preferred open position.

Press ■ to stop the blind and tap ▲ or ▼ to fine tune the position.

Confirm your new open position by pressing ■ and ▲ simultaneously. The motor will jog twice, beep and the green LED will flash.

To modify the closed position:

Press and hold ■ and ▼. When the motor jogs and beeps, release the buttons.

Press and hold ▲ or ▼ as required until the blind is in your preferred closed position.

Press ■ to stop the blind and tap ▲ or ▼ to fine tune the position.

Confirm your new closed position by pressing ■ and ▼ simultaneously. The motor will jog twice, beep and the green LED will flash.

Note: If you have already programmed a favourite position, you will need to reset it if you change the open or closed positions.

Factory Resetting Your Blind

To factory reset your blind, press the **Setting** and **Manual** buttons simultaneously for six seconds. The motor will jog twice, beep, and both the red and green LEDs will flash to indicate all user-programmed settings have been deleted.



Electric Blinds - Recycling Expired Batteries

We are committed to reducing waste. As part of this commitment we will accept returned batteries and arrange for the recycling of expired batteries from your electric blind.

To arrange collection:

- Call 01924 481729 - and let us know you are planning to return your battery.
- Remove the motor housing the battery from the blind and package securely, including your original order number on the packaging.
- Arrange delivery of your package via a courier of your choice.
- Upon receipt the battery will be recycled with appropriate waste management services.