

BLINDS DIRECT

DEFINED BY QUALITY

ROLLER BLIND FITTING INSTRUCTIONS

FITTING COMPONENTS

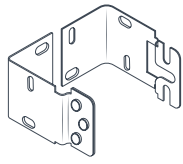

End brackets
x2

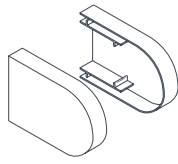

Bracket covers
x2

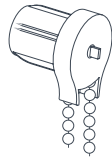

Winder
with chain

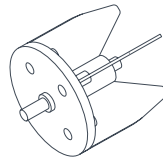

Pivot Roller

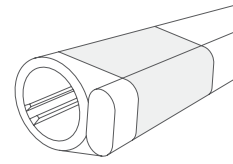

Roller &
Bottom weight bar

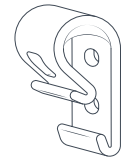

P-Clip

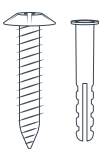

Screws and
rawl plugs
x5

FITTING HARDWARE



Metal tape
measure



Drill



Philips head
screwdriver



Step ladder



Drill bit
ø 6mm



Pencil

1 INSTALLING THE MECHANISM

Decide at which end of the blind you want the chain to be. The following instructions are for installing a blind with a chain on the right. If you want your chain to be on the left, simply swap the positions of your brackets around.

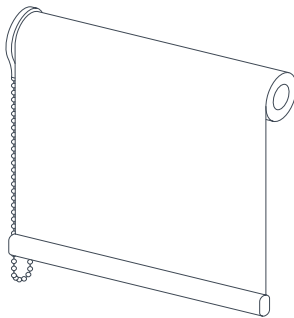

Left

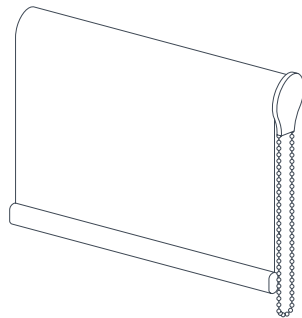

Right

2 INSTALLING THE MECHANISM

Insert the winder with chain and the pivot roller into the relevant parts of the blind, as shown below.

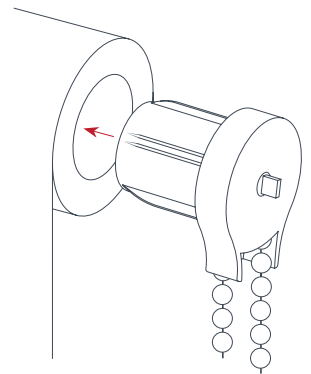
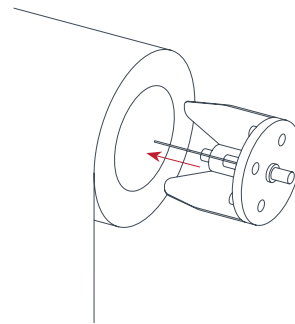

3 BRACKET POSITIONING AND FIXING

Mount your brackets as desired. Remember that you need clearance space with the wall fix method.

A - Wall Fix

IMPORTANT NOTE

The roller blind will be raised above the bracket. Please make sure you have enough space for your blind to fit when installing close to the ceiling.

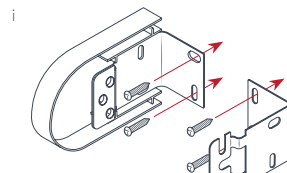

Remove cover from the chain
end bracket before installing.

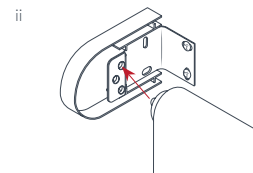

Insert blind into
the upper hole.

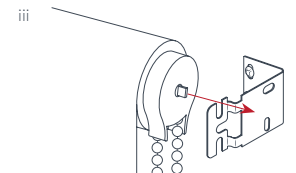

B - Top Fix

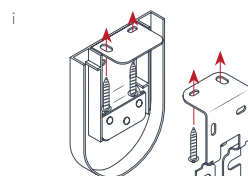

Remove cover from the chain
end bracket before installing.

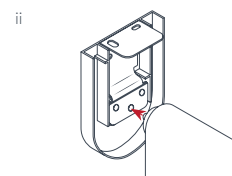

Insert blind into
the middle hole.

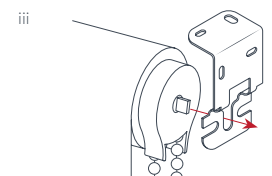

3 BRACKET POSITIONING AND FIXING

Mount your brackets as desired. Remember that you need clearance space with the wall fix method.

C - Recess Side Fix

IMPORTANT NOTE
Remove the bracket covers from both brackets when using this method.

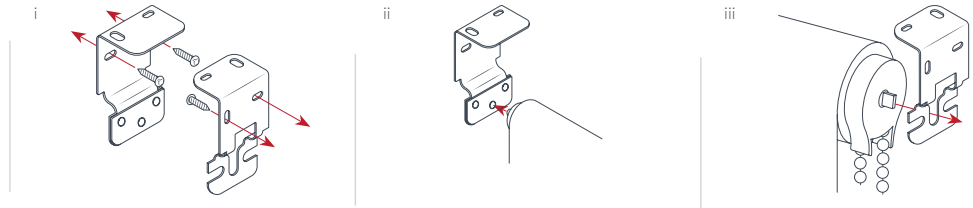

4 REATTACHING THE BRACKET COVER

Slide the bracket cover back into place at the chain end. Outside of a recess only.

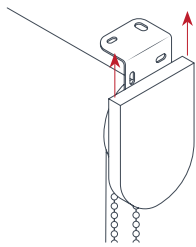

5 OPERATING YOUR BLIND

Pull on the chain loop to operate the blind.

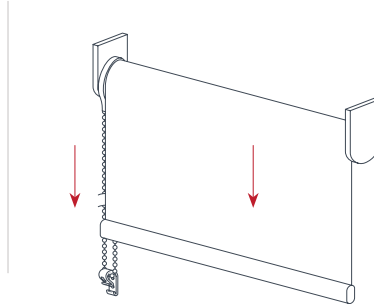

6 ROLLER

Always keep at least a full revolution of fabric on the roller.

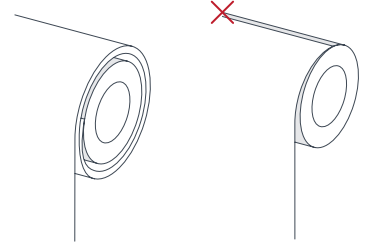

7 ATTACHING P-CLIPS

On roller blind chains, you will see a P-Clip. If it has become unattached, simply thread it back onto the chain.

Take the P-Clip roller chain and place it against the wall where you wish to install it. Make sure the chain is taut. Mark its position with a pencil. Drill a hole and secure the P-Clip with a screw. You can use a rawl plug if necessary. The chain should now be under constant tension.

P-Clips should be installed at the maximum distance possible from the control mechanism. This will prevent the looped chain from becoming slack.

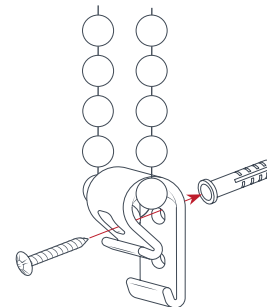

WARNING

Babies and young children can be strangled by loops in pull cords, chains, tapes and the inner cords that operate the product. To avoid strangulation and entanglement, keep cords out of the reach of young children. Move beds, cots and furniture away from window covering cords. Do not tie cords together. Make sure cords do not twist and create a loop.

The assembly and installation of this product can be completed by non-professionals, in accordance with current trade and safety standards. Please consult a professional if you are in doubt.