

## SHUTTER FITTING INSTRUCTIONS

### FITTING COMPONENTS

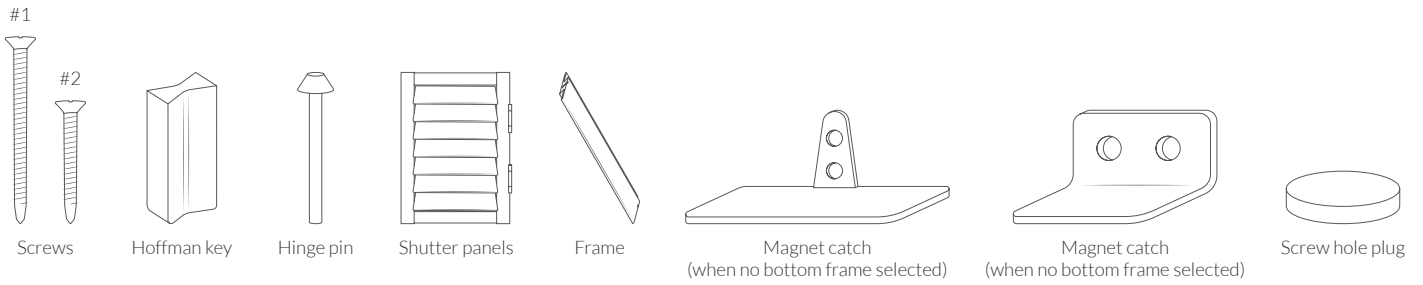

### FITTING HARDWARE



## 1 ASSEMBLE THE FRAME

Carefully remove panels and frame posts from the packaging. Ensure that panels and frame posts for different windows do not get mixed together.

Place all the frame posts up on the floor face up and line up the matching corners.

Take the left frame post and the bottom frame post and place on a flat, solid surface. We recommend using a dust sheet or equivalent to protect both surface and shutter.

Line up the Hoffman Key (the small notch at the end of your frame) in the pre-cut grooves on the ends of the frame posts. Insert the rounded edge first.

Make sure the corners are flush together. Press down on the left frame post to lock the Hoffman Key in place, then press down on the bottom frame.

Repeat for the remainder of the corners until the frame is complete.

\* Please note: although some frames may have fewer than four posts, they are still attached in the same manner as above and some of the posts will have flat, not mitred ends.

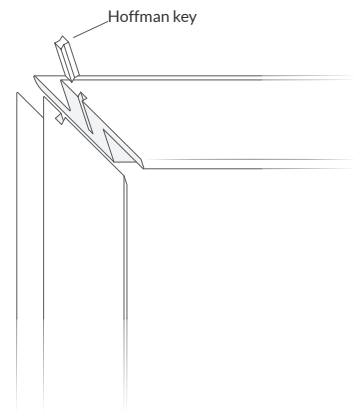

## 2 PACK OUT THE FRAME

Lift the frame into the recess in the position you wish to fix it. Make sure the frame is level, using shims or packers and a spirit level, and ensure the frame is fitted squarely into the recess. Use a tape measure to centre the frame.

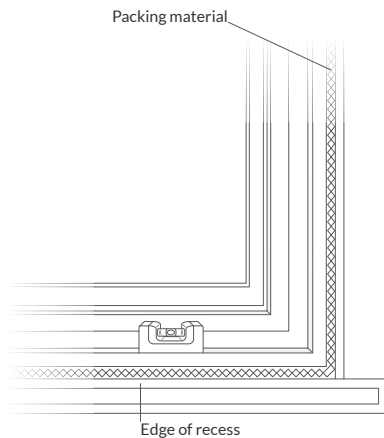

## 3a SIDE MOUNTING

Choose whether you wish to side mount or wall mount (3b) the frame.

To side mount the wall into masonry or plastered wall, drill through the inside of the frame into the recess wall at each corner. Make sure the drill bit has marked the wall behind the frame to indicate the position of the fixing holes.

Remove the frame then drill holes on the marked places with a suitable drill bit. Insert the wall plugs and return the frame to the fitted position.

Make sure the holes in the frame are lined up correctly with the holes in the wall and screw the top right hand corner into position.

Level the frame using your spirit level, then screw in the top left hand corner.

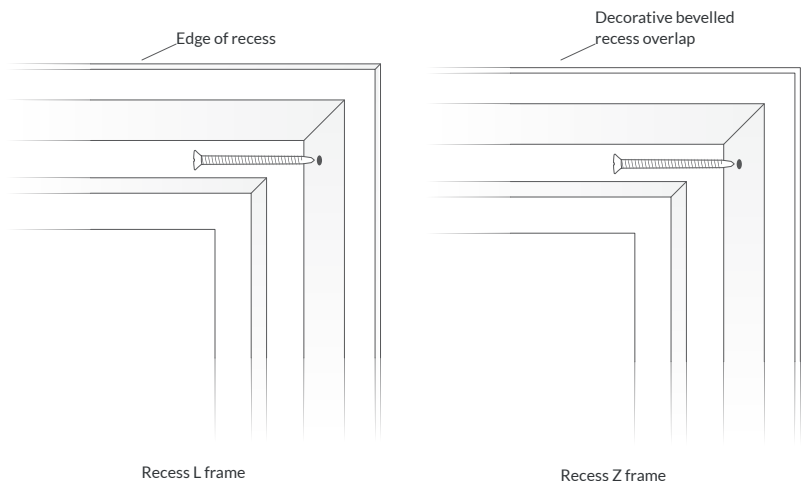

## WALL MOUNTING

To mount the frame with a wall mounting, remove the insert covers to gain access to the drill holes on the front of the frame. Line up the shutter to be fixed on the wall face and mark the wall through the drill holes.

Remove the frame then drill holes on the marked places with a suitable drill bit. Insert the wall plugs and return the frame to the fitted position.

Make sure the holes in the frame are lined up correctly with the holes in the wall and screw the top right hand corner into position.

Level the frame using your spirit level, then screw in the top left hand corner. Once the frame is fitted correctly, replace the covers to conceal the screw heads.

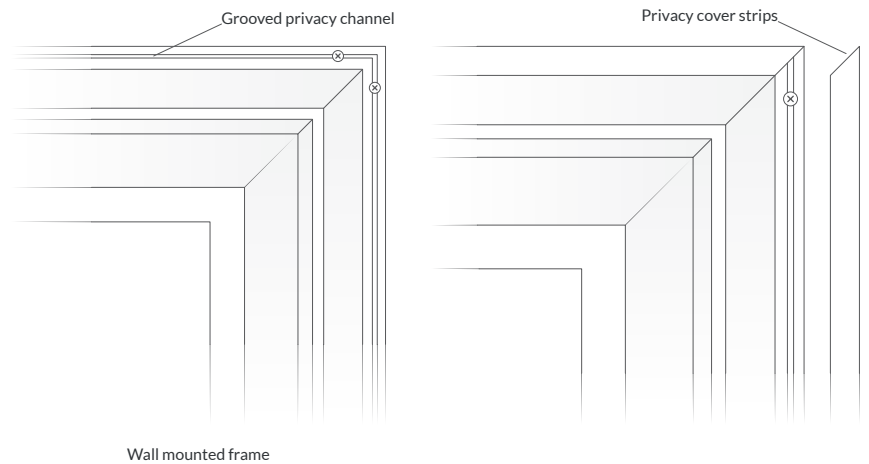

## 4

## MOUNT THE DOORS

To mount the doors, hold the door in place then line up the prefitted hinges on the door and the frame.

Once you have done this, slide the hinge pin vertically through the hinges to lock them in place.

Ensure that all hinges are secure and locked in place before letting go of the door.

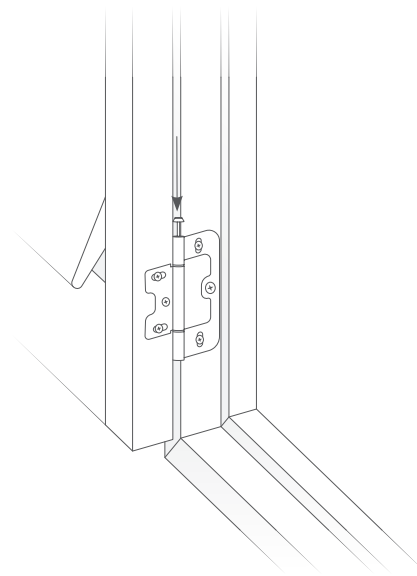

## 5

## FINALISE THE FITTING

Now that all parts of the shutters are secure, check that the fit is correct by opening and closing the doors. The doors and the frame each have magnets which keep the doors tight when closed. Open and close the doors to ensure these magnets are aligned. Make sure that the shutter doors are the correct way up when installing.

No light should be able to enter the room when the louvres are in the upright position, and should be rotated downwards to let light in.

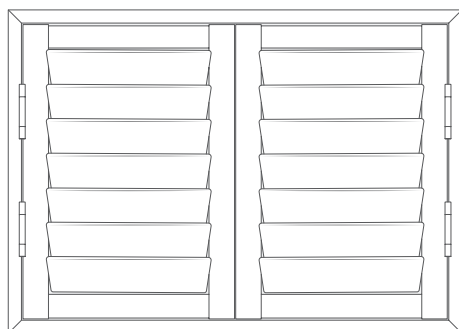

Check the doors are closed and are evenly aligned

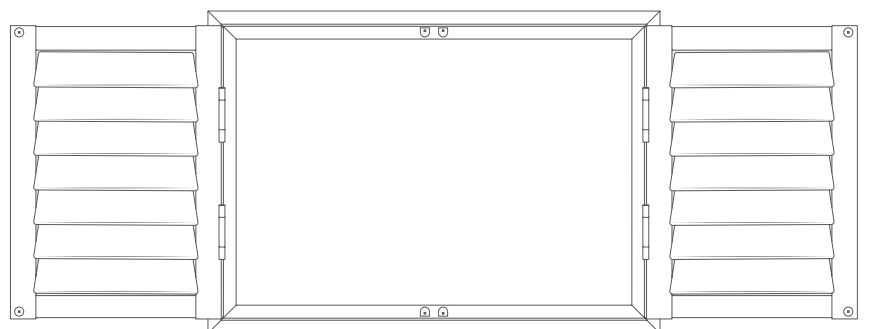

Mark where the magnets touch the frame